

WALL / PILASTER CAPS

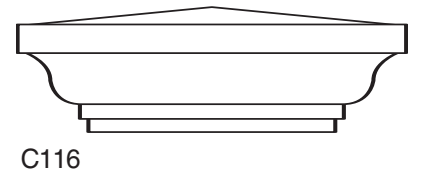
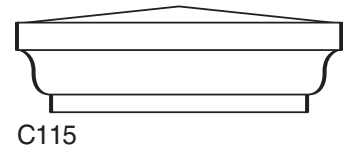
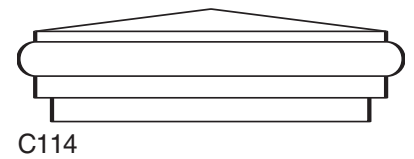
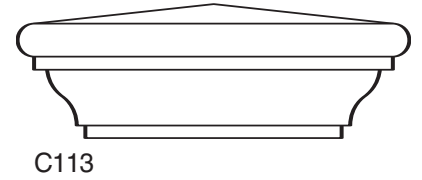
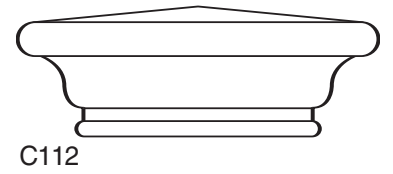
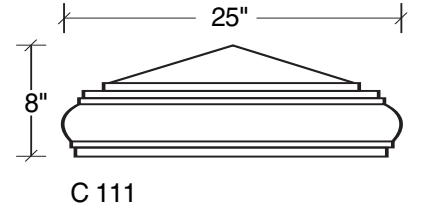
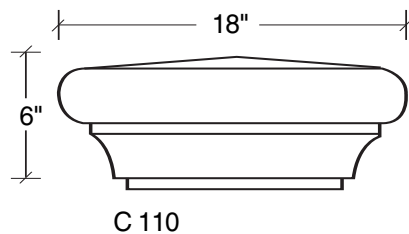
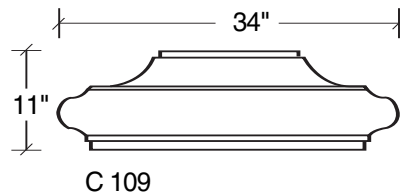
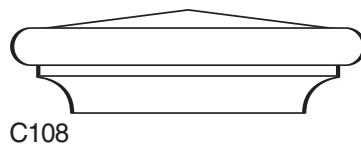
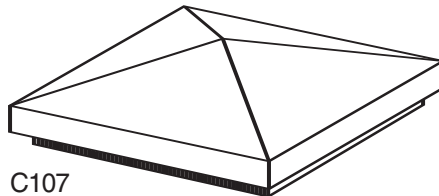
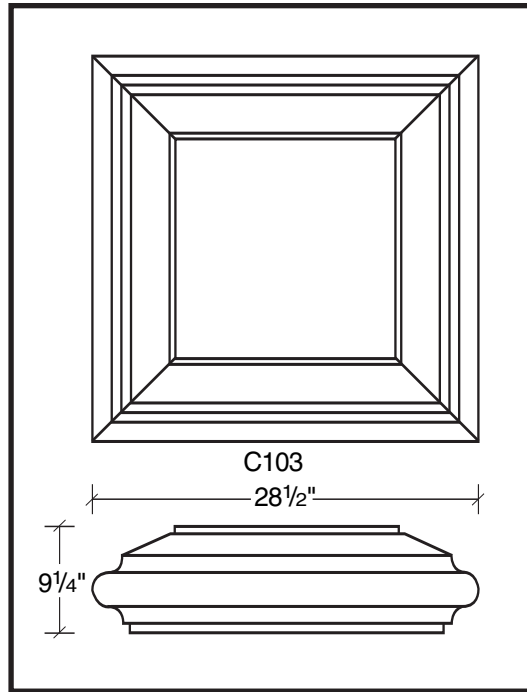
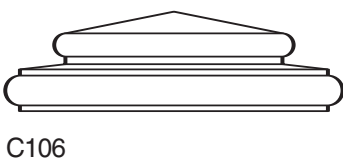
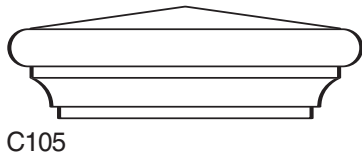
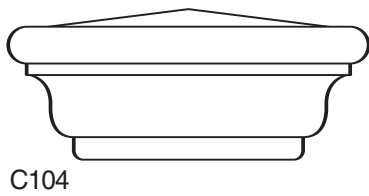
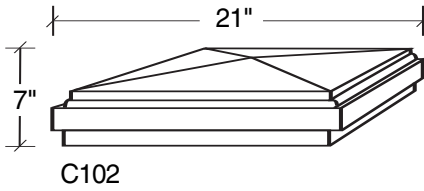
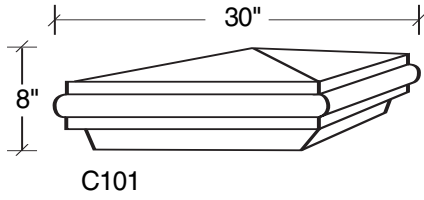
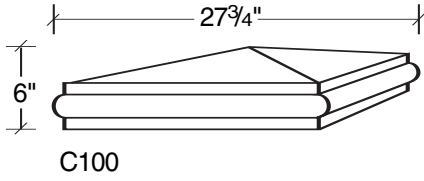

ALSO AVAILABLE IN LITE-CAST STONE FINISH

909-598-3856
FAX 909-598-1491