

SPECIALTY VEFOAM® PRODUCTS

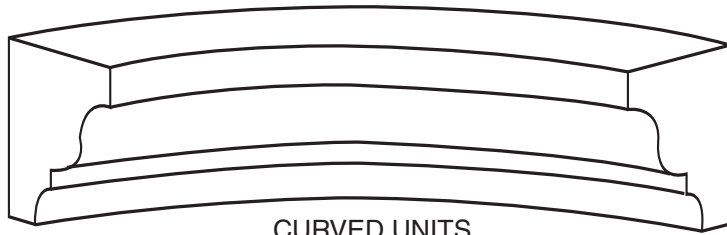

CURVED UNITS
(INSIDE AND OUTSIDE)

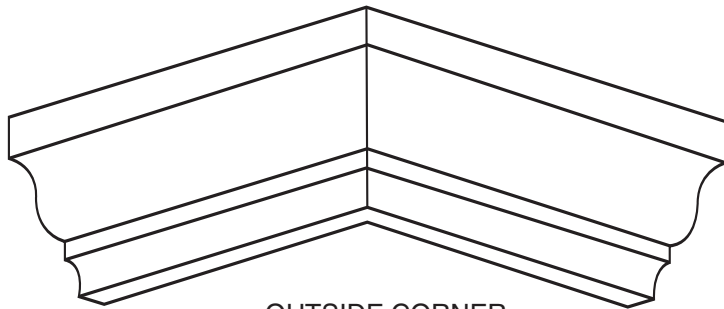
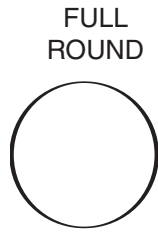

OUTSIDE CORNER

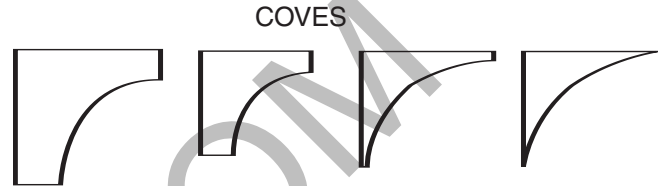

FINIALS

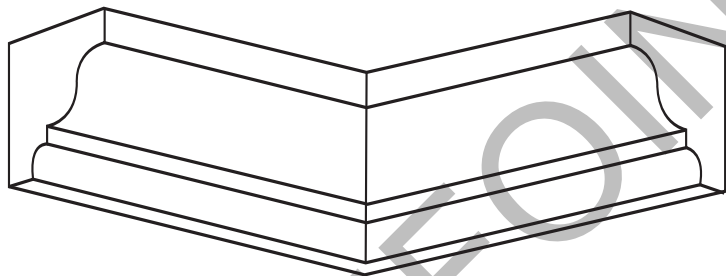
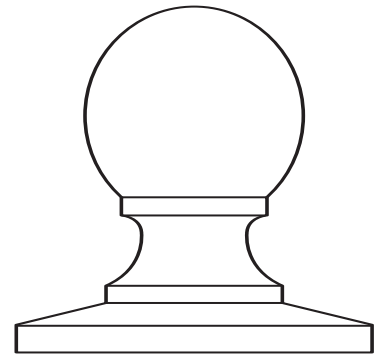
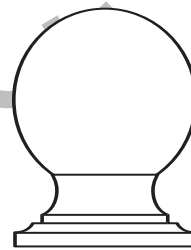

INSIDE CORNER

SIDE

FRONT

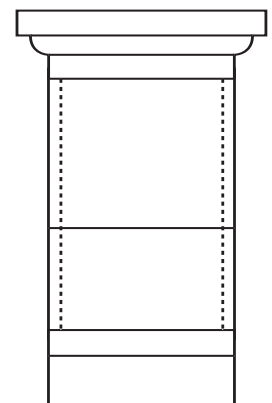
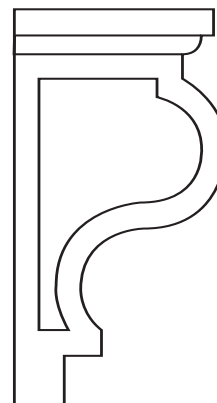

SIDE

FRONT

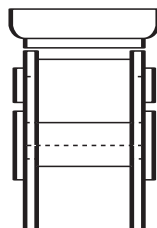
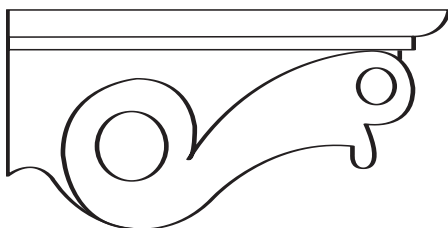

CORBEL

CORBEL

SPECIALTY VEFOAM® PRODUCTS

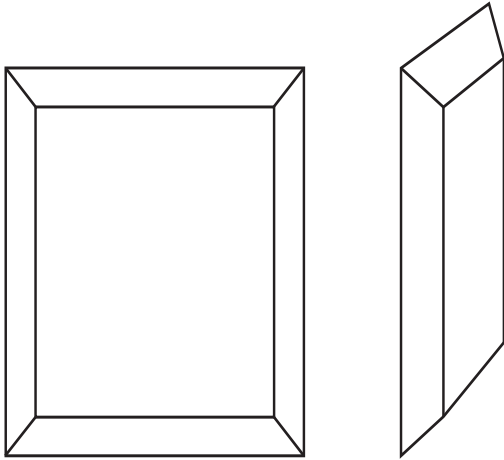

QUOINS

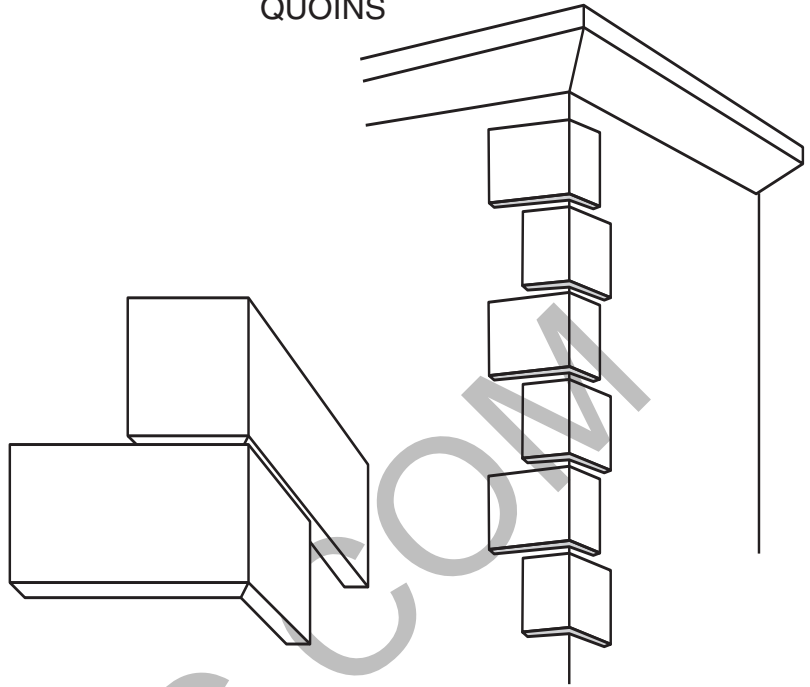

AVAILABLE IN STRAIGHT
OR RADIAL FRONT EDGES

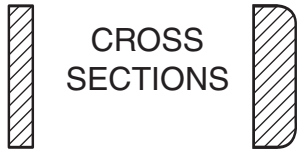

PEDIMENTS

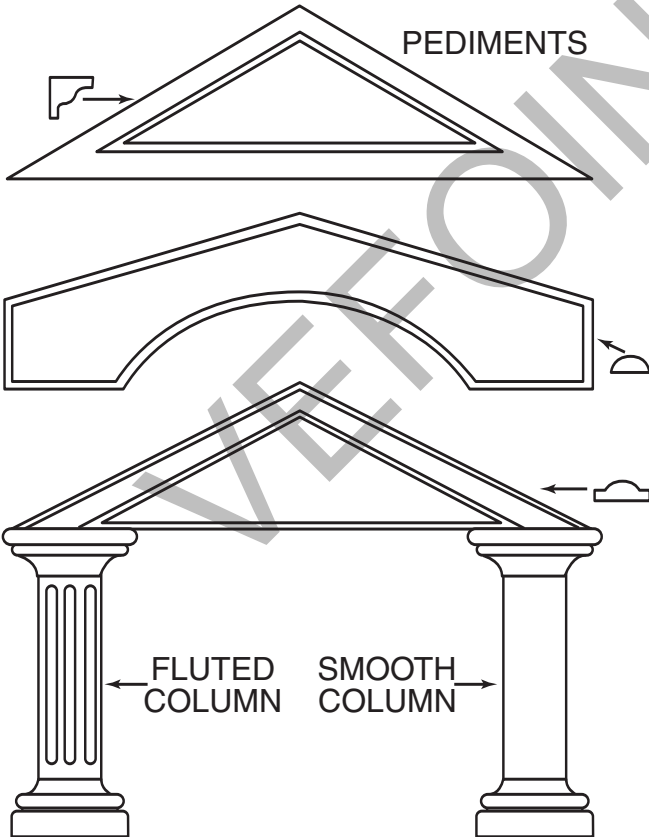

QUOIN
PANELS

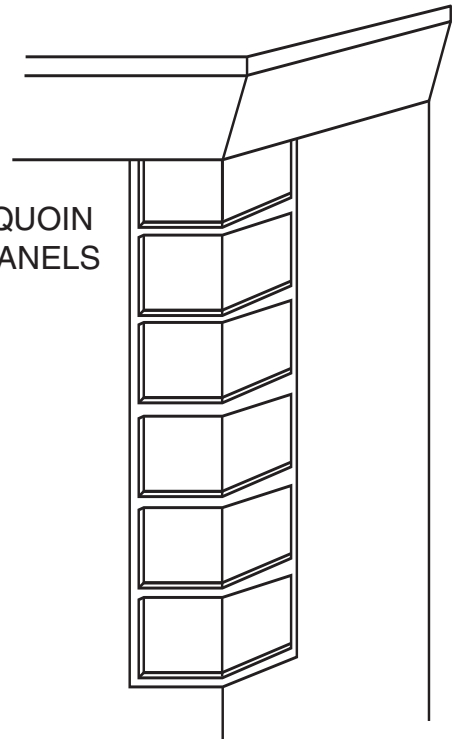

AVAILABLE IN FOAM ONLY, BASE OR SMOOTH COATED FOAM, OR LITE-CAST STONE™



B-1



B-2



B-3

B-3 ALSO AVAILABLE IN SOLID CAST CONCRETE

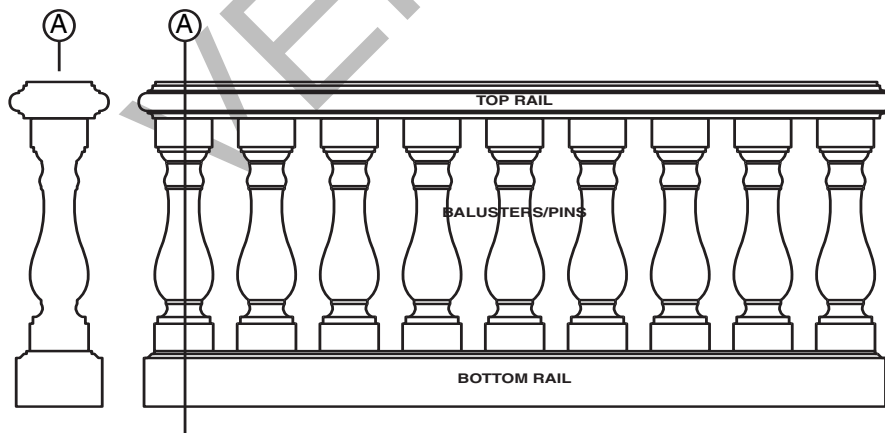
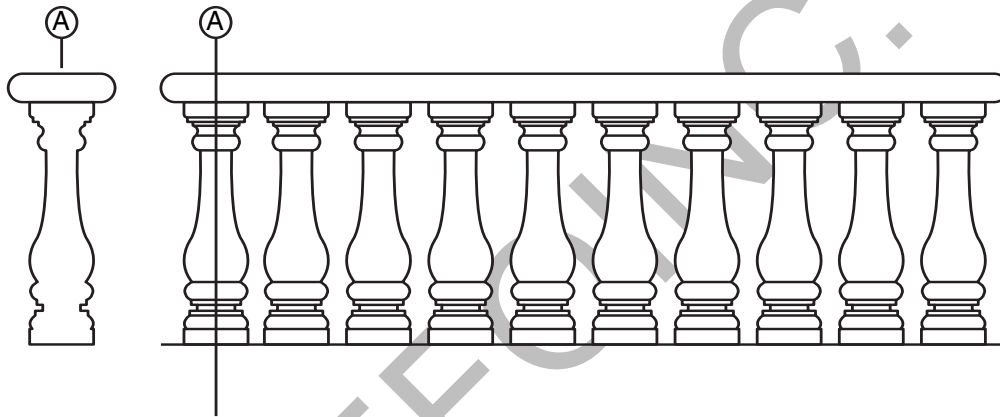

TR-1

B-4



BR-1

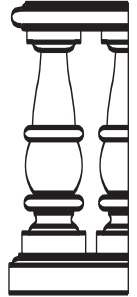

TR-2

B-5



BR-1

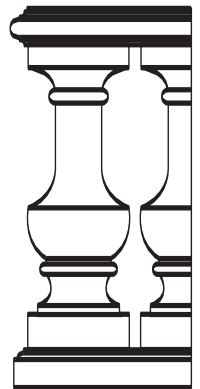

TR-3

B-6



BR-1

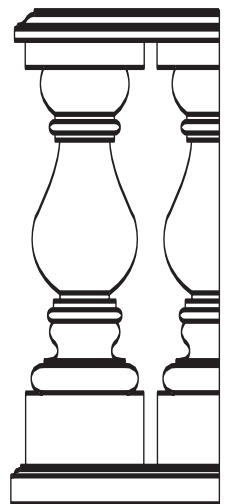

BALUSTER ASSEMBLIES

AVAILABLE ONLY IN LITE-CAST STONE™

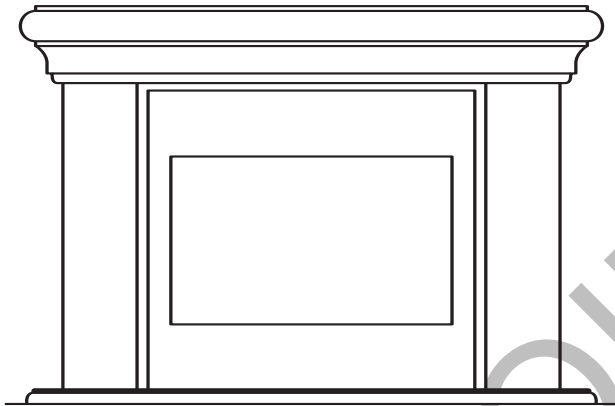
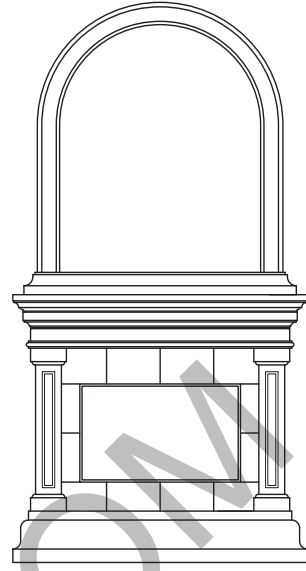
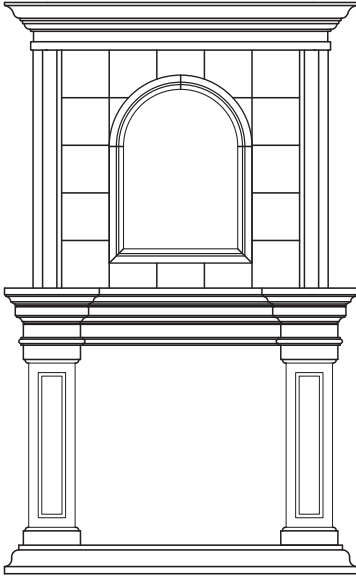

FS1

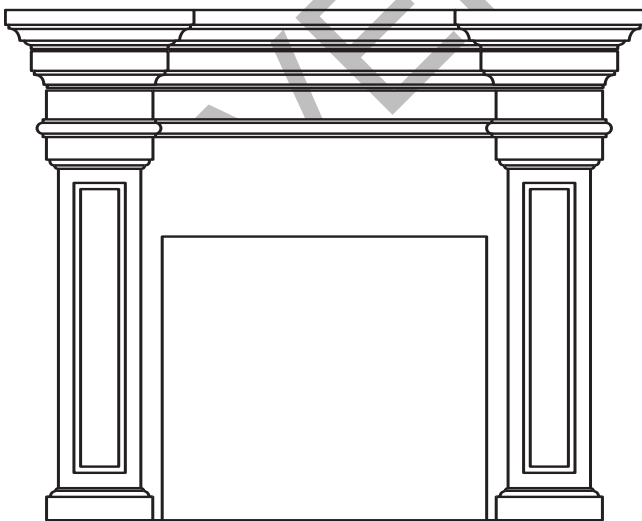
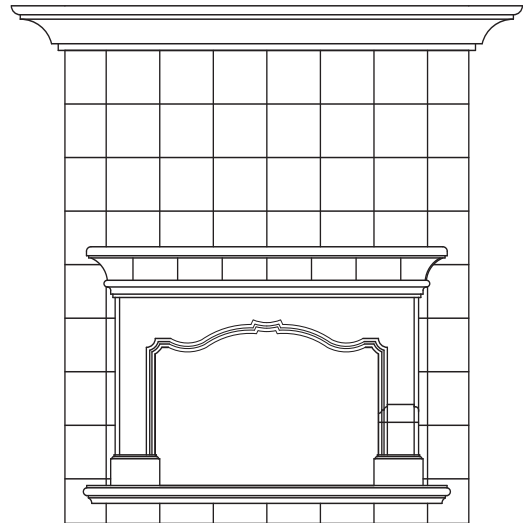

FS3

