

WALL / PILASTER CAPS

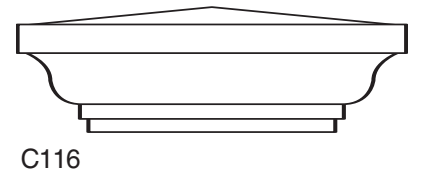
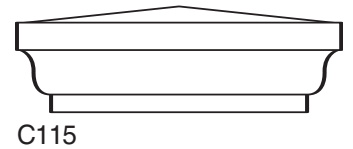
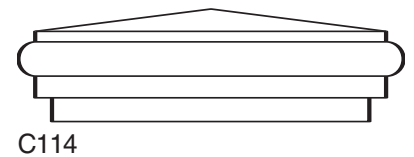
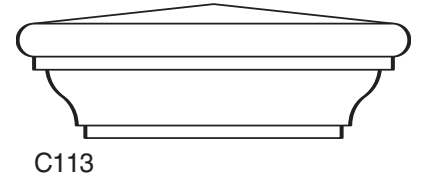
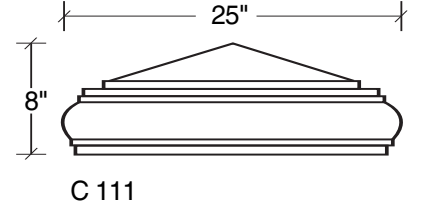
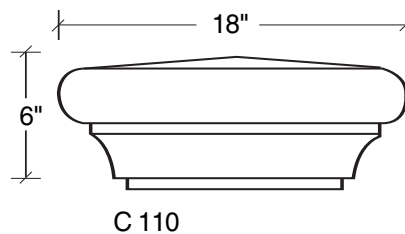
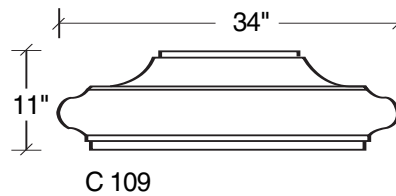
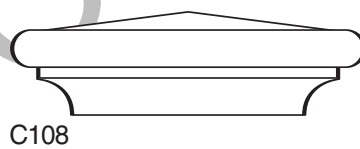
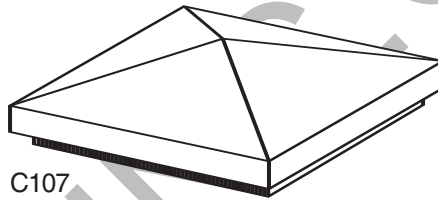
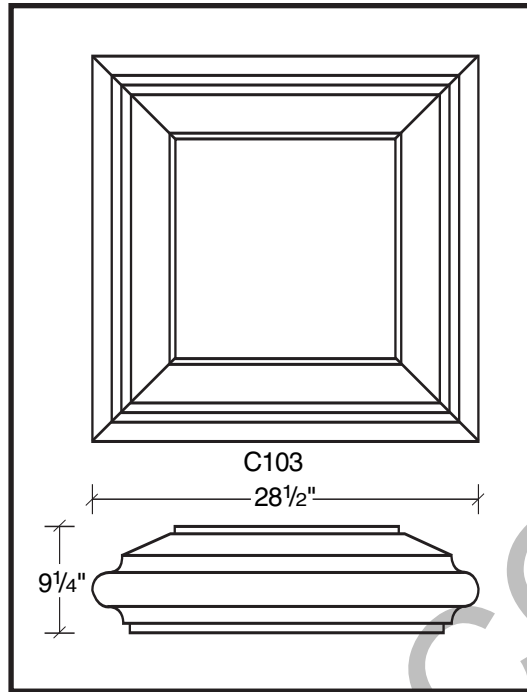
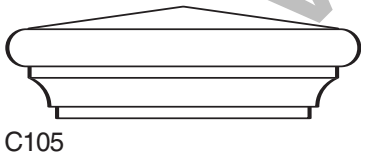
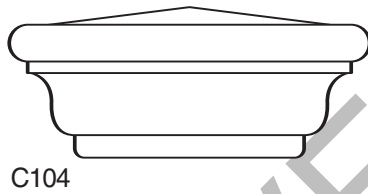
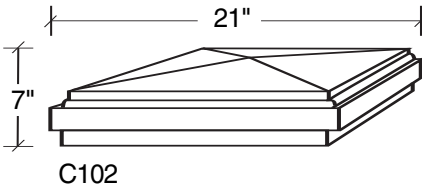
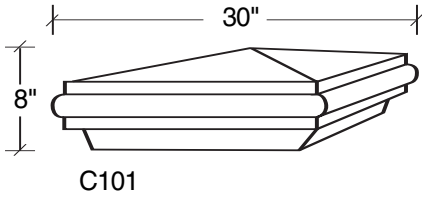
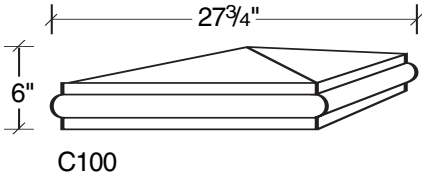

ALSO AVAILABLE IN LITE-CAST STONE™

909-598-3856
FAX 909-598-1491